

Dragonfly

High-speed Confocal Imaging Platform



Controlled by Fusion

Acquire | Visualize | Analyze

- ✓ Instant Confocal
- ✓ Simultaneous multi-colour TIRF
- ✓ Laser widefield imaging
- ✓ Single molecule imaging
- ✓ VIS-NIR wavelengths
- ✓ Super-Resolution
- ✓ Borealis illumination
- ✓ GPU accelerated deconvolution

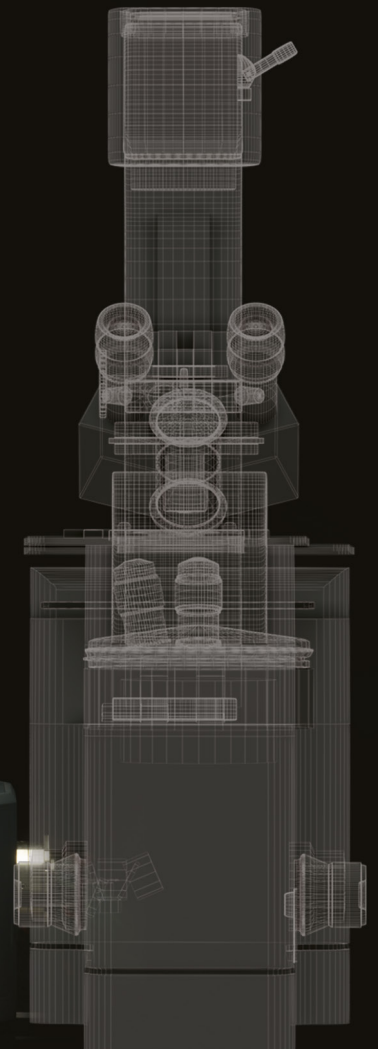
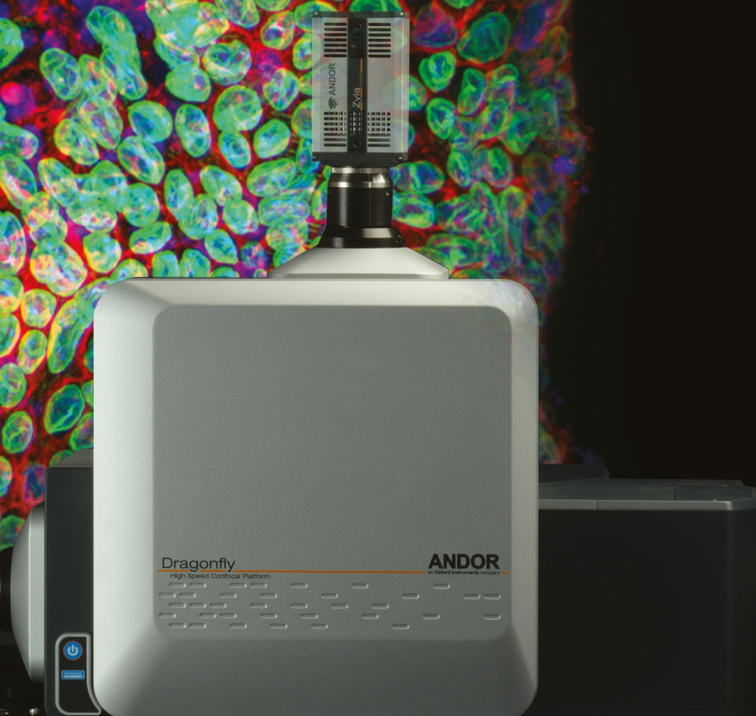

Introducing Dragonfly

It's more than confocal...

Dragonfly is a **high-contrast multi-dimensional imaging platform** capable of four key imaging modalities.

At its core is a **multi-point confocal** for **high-speed and high-sensitivity** imaging. Capturing at speeds **at least 10x faster than conventional confocal technology**, Dragonfly is the optimal solution for live cell imaging, providing low phototoxicity and photobleaching, or perfect for **fast volume acquisition** of fixed samples.

Super-resolution is a second feature of Dragonfly, which can leverage a variety of techniques to push the resolution beyond the diffraction limit: **GPU-accelerated deconvolution; SRRF-Stream** and **dSTORM**.

The third high-contrast technique **TIRF (total internal reflectance) microscopy** is available as a factory-installed option on the 500 series. This is the tool of choice for imaging protein dynamics at or proximal to the cell membrane and single molecule imaging. Dragonfly TIRF is capable of **simultaneous multi-colour TIRF**, allowing excitation penetration depth of two simultaneous wavelengths to be matched for accurate interpretation of 3D localization.

A fourth available imaging mode is **laser-illuminated widefield epifluorescence**. This mode is ideal for applications that do not benefit from confocal imaging, such as yeast and other very thin samples, or applications that require high laser power, like single molecule localisation. Imaging in widefield using Dragonfly, you can share the same cameras and lasers with the other modes and avoid switching ports and turrets in the microscope.

Finally, Dragonfly utilizes a range of additional integrated functions to enhance image quality and provide more tools for additional applications. **Camera zoom optics** optimize sampling and resolution according to the objective required by your application. **Illumination zoom** on the 500 series increases excitation power density for high intensity applications like single molecule localization.



Above - Dragonfly 200 series model. The Dragonfly 500 series model is shown on the front cover.

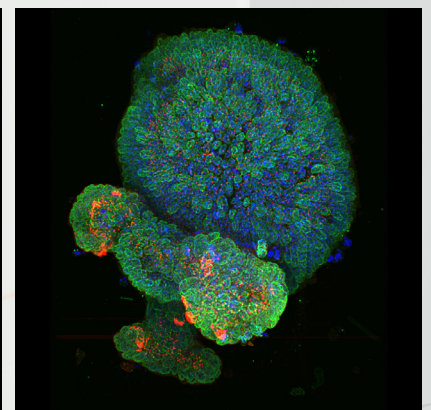
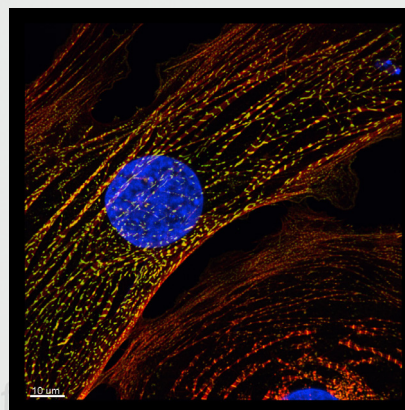

Above - Left: Human iPS cardiomyocyte labelled with actinin488 and phalloidin560. Courtesy of Dr Travis Hinston, The Pat and Jim Calhoun Cardiology Center, University of Connecticut Health Center & The Jackson Laboratory for Genomic Medicine. Right: Mouse Colonic Epithelial Organoid. DNA (blue), LaminB1 (green, nuclear envelope) and GM130 (red, cis-golgi). Courtesy of Ronan Mellin & Dr. Luke Boulter MRC Human Genetics Unit, University of Edinburgh.

Spectral range	Confocal speed	Aperture	Camera zoom	Illumination zoom	Pinhole Sizes
400-800 nm	400 fps	22 mm	1x, 1.5x, 2x	1x, 2x, 4x, 6x	25, 40 µm

Features & Benefits



Hardware Feature	Benefits	200 Series	500 Series
High speed confocal (micro-lens enhanced)	<ul style="list-style-type: none"> Up to 400 fps for fast cell dynamics At least 10x faster than conventional confocal 	✓	✓
Large field of view (16.6 x 14.0 mm)	<ul style="list-style-type: none"> Capture more in a single image Matches large sCMOS sensors 	✓	✓
Borealis™	<ul style="list-style-type: none"> Provides: stability, throughput, uniformity, extended wavelength range. 	✓	✓
Laser-illuminated widefield mode	<ul style="list-style-type: none"> For imaging thin specimens and single molecules 	✓	✓
16-bit dynamic range	<ul style="list-style-type: none"> Capture both weak and bright signals without saturation 	✓	✓
Motorized 4 position emission-splitting dichroic cassette	<ul style="list-style-type: none"> Optimal flexibility for simultaneous dual colour imaging (e.g. single camera bypass + 3 chromatic splitters) 	✓	✓
Active blanking	<ul style="list-style-type: none"> Laser illumination timed with camera exposure to minimize phototoxicity and photobleaching 	✓	✓
Exchangeable emission filter wheels	<ul style="list-style-type: none"> To comprehensively image multiple fluorophores when using up to 8 laser lines for excitation (UV to NIR) RFID-tagged for filter update in user interface 	✓	✓
Camera magnification (1x, 1.5x & 2x)	<ul style="list-style-type: none"> For flexible higher resolution imaging and pixel scaling to achieve Nyquist sampling over a wide range of objectives and pixel sizes 	2-position motorized (option)	3-position motorized
2 pinhole diameters (25 µm and 40 µm)	<ul style="list-style-type: none"> High contrast imaging at low and high magnification for large samples to subcellular imaging 	Option	✓
Simultaneous multi-color TIRF	<ul style="list-style-type: none"> Choice of 7 wavelengths up to 640nm Any two colours simultaneously - match penetration depth of two labelled targets instantly 	-	Option
Illumination zoom*1	<ul style="list-style-type: none"> Delivers higher illumination power density for applications such as localization microscopy 	-	✓
Astigmatic lens*1	<ul style="list-style-type: none"> For 3D single molecule localization imaging in a volume 	-	Option

✓ = Feature available as standard

Option = Feature available as an option

- = Feature not available

Software Feature

Benefits

Real-time 3D rendering	<ul style="list-style-type: none"> Immediate visual feedback on experimental progress to evaluate data and make appropriate decisions in real-time
ClearView-GPU™: GPU-accelerated deconvolution in parallel with acquisition or as post-processing	<ul style="list-style-type: none"> Up to 50x faster processing than non-GPU based deconvolution solutions Run deconvolution during an experiment to save time Choose an algorithm to balance speed and quality according to your image properties
Imaris file format	<ul style="list-style-type: none"> Easy transfer of data to Imaris for comprehensive downstream multi-dimensional analysis

Technical Data

General Specifications^{*1}

Confocal/Widefield Wavelength Range	Excitation range: 400-800 nm Emission range: 420-850 nm
TIRF Input Wavelength Range	400-640 nm
Confocal/Widefield Input Power	2 W maximum for combined wavelengths
Confocal Pinhole Diameter	25 µm and 40 µm (option)
Disk Type	Micro-lens enhanced dual disk
Active Blanking	Laser illumination timed with camera exposure to minimize phototoxicity and photobleaching
Output Power	As classified under IEC 60825-1 or the regional equivalent: 500mW maximum Class 3B (typical). May be Class 4 with 1W maximum With some laser combinations.
Lateral Resolution	Diffraction limited in 19 mm diagonal
Illumination Uniformity	Less than 6% roll-off ^{*2}

Mechanical Specifications

	200 Series	500 Series
Weight	39 kg approx. without cameras/accessories	65 kg approx. without cameras/accessories
Dimensions (WxDxH) inches [mm]	32.3 x 22 x 18.8 [821 x 558 x 477] (with installation handles) 32.3 x 17.8 x 18.8 [821 x 452 x 477] (without handles)	31.2 x 30.7 x 19.3 [792 x 780 x 489] (with installation handles) 31.2 x 26.5 x 19.3 [792 x 674 x 489] (without handles)

Note: Addition of camera(s) will add up to 7.4 [189] to height and up to 3.7 kg weight per camera.

Frame Rates^{*3}

Maximum Confocal Frame Rate (FPS)^{*4}

Zyla 4.2	Frame Rate (sustained / burst) ^{*5}	
Array Size	USB 3.0	10-tap
2048x2048	40/100	66/100
1024x1024 (2x2)*	100/100	100/100
2048x1024	80/200	133/200
2048x512	133/400	200/400
2048x128	400/400	400/400

iXon 888 ^{*6}	Array Size			
Binning	1024x1024	512x512	256x256	128x128
1x1	24	48	94	123
2x2	48	94	123	178
4x4	76	123	178	320

Maximum Widefield/TIRF Frame Rate (FPS)

Zyla 4.2	Frame Rate (sustained / burst) ^{*5}	
Array Size	USB 3.0	10-tap
2048x2048	40/100	98/100
1024x1024 (2x2)*	100/100	100/100
2048x1024	192/200	200/200
2048x512	406/406	422/422
2048x128	1627/1627	1691/1691

iXon 888 ^{*6}	Array Size			
Binning	1024x1024	512x512	256x256	128x128
1x1	26	50	96	171
2x2	50	94	110	285
4x4	92	167	281	426

* Matches pixel size of iXon Ultra/Life 888 models for dual camera simultaneous operation

Technical Features Explained



1 Borealis- Patented Perfect Illumination Delivery™

Integral to the illumination pathway for confocal and widefield modes is **Borealis**. Borealis utilizes a multimode fibre and microscope correction optics to provide exceptional illumination optimising the following parameters: coupling stability and efficiency, excitation throughput, imaging uniformity and spectral range.

Feature	Benefits
Uniformity improvements of up to 10x	<ul style="list-style-type: none"> Accurate cross-field analysis Seamless tiled/montage imaging
Throughput improvements up to 3x	<ul style="list-style-type: none"> Lower laser powers required = lower cost More light for high power applications (e.g. single molecule localisation microscopy)
Extended spectral range (400-800 nm excitation)	<ul style="list-style-type: none"> Greater choice of fluorescent probes NIR imaging to avoid autofluorescence or for deeper imaging
Better axial geometry	<ul style="list-style-type: none"> More accurate three dimensional image reconstruction
Enhanced laser coupling stability	<ul style="list-style-type: none"> Longer term illumination stability Reduced risk of alignment drift and correction

Broad Spectrum Delivery

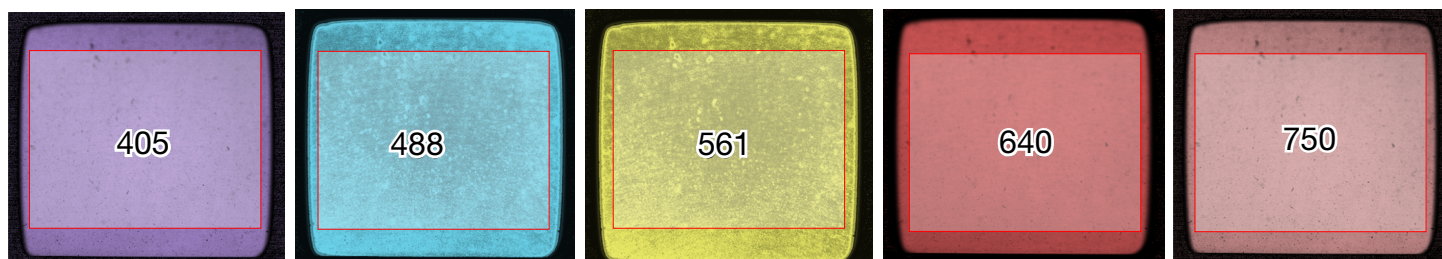

A series of intensity maps captured at the exit window of Dragonfly across all major wavelengths from 405 nm to 750 nm. A high degree of uniformity is visible. This uniformity then translates to the sample with high quality chromatically corrected objectives in the microscope.

2 Camera Zoom

At each camera port there is a motorized 3 position magnification changer (500 series) or single/double motorized changer (200 series) containing 1x, 1.5x and 2x optics. If you are using a sensitive camera with a larger pixel, such as on the iXon Ultra 888 (13 μm), moving to a 2x zoom allows you to reach Nyquist sampling with 60x and 100x high NA objective to ensure all the finest details from your sample are captured. The level of detail is then only limited by the objective you use.

Right: A comparison of the same cell with sub-images showing enhanced resolution of fine detail when moving from 1x, 1.5x and 2x zoom respectively.

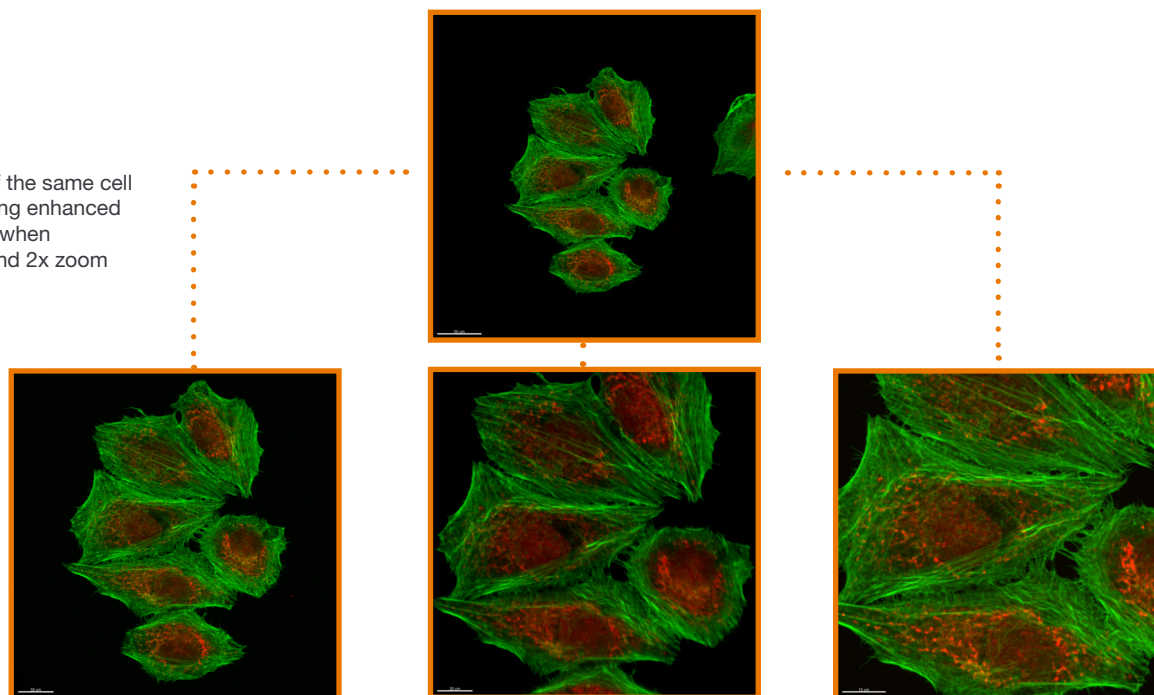

Relative Zoom	1x	1.5x	2x
Description	Imaging Field area = 1x Specimen Illumination area	Imaging Field area = 0.67x Specimen Illumination area	Imaging Field area = 0.5x Specimen Illumination area

3 Super-Resolution

Dragonfly can utilize three super-resolution techniques – GPU-accelerated deconvolution; SRRF-Stream and dSTORM as well as widefield and confocal.

	Widefield	Confocal	ClearView-GPU™	SRRF-Stream	dSTORM
Dragonfly Model	All models	All models	Option (All models)	Option (All models)	500 series only
Lateral Resolution (typical FWHM) *7	245 nm	238 nm	200 nm (widefield); 140 nm (confocal)	50 – 150 nm	20 – 50 nm
Axial Resolution (typical FWHM) *7	573 nm	523 nm	500 nm (widefield); 280 nm (confocal)	573 nm (widefield); 523 nm (confocal)	50 nm (with 3D lens option; 1 μm total range)
Special probes / sample prep.	No	No	No	No	Yes
Frame rates (FPS, typical)	Unlimited	400	Unlimited (post-processing)	1 fps (@512x512 pixels)	<0.01
Software Processing	None	None	Fusion*	Fusion**	3rd party / open-source options

* Clearview-GPU™ licence required

** Camera licence required

4 Illumination Zoom (500 series)

The illumination path for widefield and confocal modes has a motorized 4-position zoom mechanism. This enables the illumination light to be focused into a smaller area and deliver a higher power density to the sample when an application requires more light from the laser source, for example dSTORM.

	Mode	1x Zoom	2x Zoom	4x Zoom	6x Zoom
Increase in power density	Confocal	1x	2x	not used	not used
	Widefield	1x	4x	16x	36x

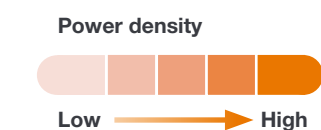

Right: Using the Illumination Zoom to increase the power density of illumination.

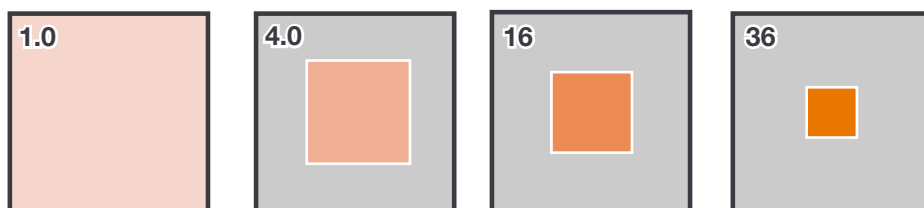

5 Selectable Illumination Field Aperture Size

Dragonfly includes a variable aperture to best match the area of illumination to the camera sensor format, the zoom illumination size, or the field size covered with the camera zoom. The purpose of controlling the field aperture is to ensure the sample is not over-illuminated ensuring minimal phototoxicity and photobleaching. Stray light is also reduced, providing higher contrast images.

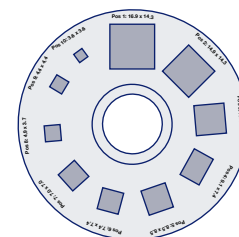

Relative illum. Power Density	Camera Magnification (nominal)	Field of view (mm)	Comments	Min Disk Area Illum. Dimensions (mm)
1x	1x	16.64x14.04	Neo & Zyla 5.5 (2560x2160 sCMOS). Full frame	16.64x14.04
1x	1x	14.04x14.04	Neo & Zyla 5.5 (2160x2160 sCMOS). Scope Quality Area Field Number Limit	14.04x14.04
1x	1x	13.3x13.3	Zyla 4.2 (2048x2048) and iXon 888	13.3x13.3
2x	1x	8.8x7.1	sCMOS 1392x1080 optically centred window	8.8x7.1
2x	1x	8.2x8.2	iXon 897	8.2x8.2
2x	2x	14.04x14.04	Neo & Zyla 5.5 (2160x2160 sCMOS) Effective pixel size = 3.25 µm	7.1x7.1
2x	1x	6.7x6.7	iXon 888 512x512 ROI Optically Centred Crop	6.7x6.7
2x	2x	13.3x13.3	iXon 888 256x256 ROI Optically Centred Crop	
2x	2x	13.3x13.3	Zyla 4.2 (2048x2048). Effective pixel size = 3.25 µm	
2x	2x	9.1x6.8	sCMOS 1392x1080 optically centred window 3.25 or 6.5 µm (binned 2x2 with higher frame rate)	4.6x3.4
2x	1x	4.1x4.1	iXon 897 256x256 ROI Optically Centred Crop	4.1x4.1
2x	2x	8.2x8.2	Works for iXon 897. Effective pixel size = 8 µm	
2x	2x	6.5x6.5	iXon 888 quadrant crop mode. Effective pixel size = 6.5 µm	3.25x3.25

Integrated Software Solutions

Fusion

Fusion has been designed to meet the requirements of today's expectations for ease of use and immediate visual feedback for data review, whilst fulfilling tomorrow's aspirations for handling multi-modal imaging.

Fusion simplifies the control of the Dragonfly system, with its multiple imaging modes, to fluorophore and imaging mode selection in just three mouse clicks. A "New Specimen" feature lets you switch specimens with two mouse clicks, refocusing the objective automatically. Once the sample is on the microscope you can control all hardware, including the XY stage with its unique software joystick. Real-time 3D visualization provides a powerful insight to your experiment, and ClearView-GPU™ deconvolution delivers both enhanced resolution and signal:noise in all dimensions and all modes of imaging.

To find out more about Fusion please see: <https://andor.oxinst.com/products/dragonfly>

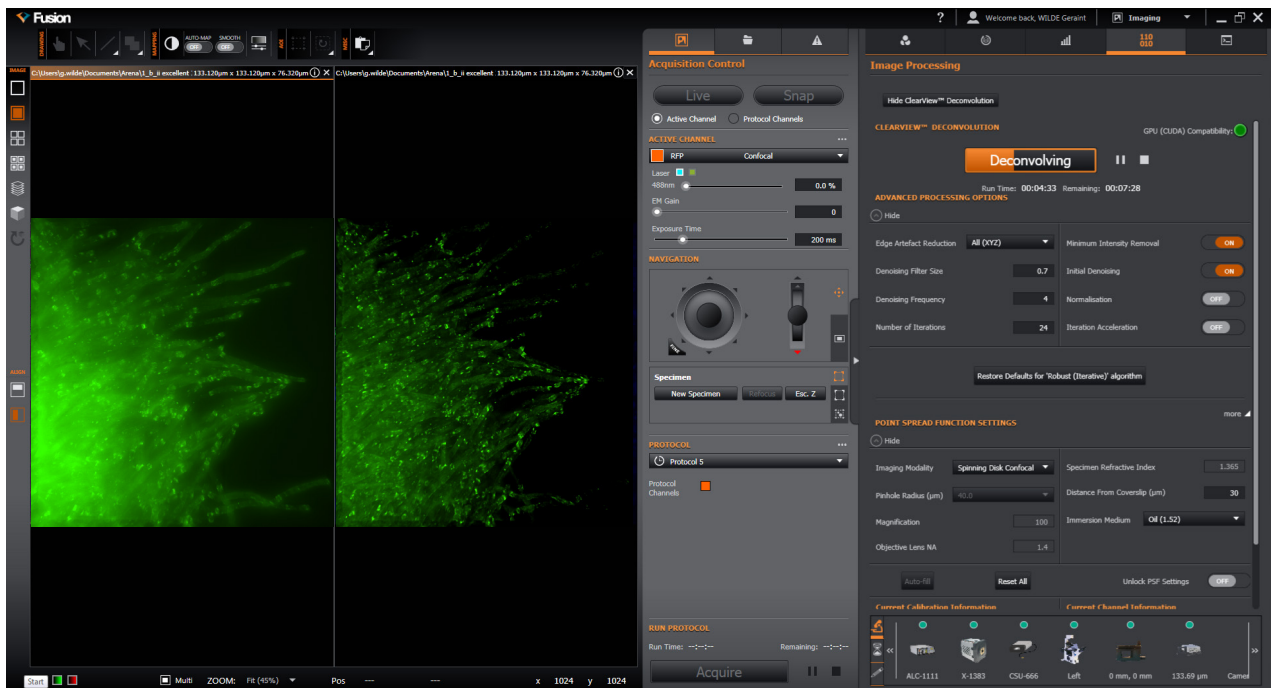

Imaris®

Saving files in Imaris format, Fusion permits easy transfer of your data into Imaris software. **Imaris Core** is a standard part of the Dragonfly package, and required for downstream editing, annotating, surface rendering, and creating sophisticated multi-dimensional movies.

Additional application-specific modules are available on request, such as measurement packages for cell biology, cell lineage, neuroscience and much more.

To find out more about Imaris please see: bitplane.com

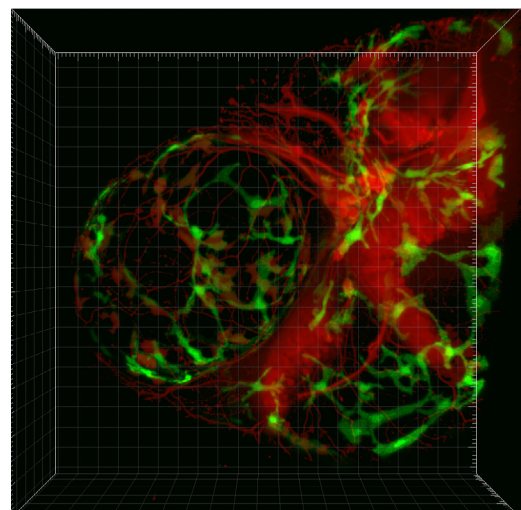

Creating the Optimum Product for You

Step 1 Select the Dragonfly Model You Require



Feature	200 Series	500 Series
Upright microscope	✓	-
Inverted microscope	✓	✓
Camera port zoom	2-position motorized (option)	3-position motorized
Zoom illumination	-	✓
TIRF	-	Option
3D astigmatic lens	-	Option
Dual cameras	Option	Option

Note: All models include workstation with Fusion and Imaris Core software.



Dragonfly 200 Series

200 Series

Description	Model Number
Single pinhole pattern, single camera port and camera port magnification options	CR-DFLY-201-40
Dual pinhole pattern, single camera port and camera port zoom options	CR-DFLY-201-2540
Single pinhole pattern, second camera port option and camera port zoom options	CR-DFLY-202-40
Dual pinhole pattern, second camera port option and camera port zoom options	CR-DFLY-202-2540



Dragonfly 500 Series

500 Series

Description	Model Number
Dual pinhole pattern, 4-position illumination zoom, single camera port, 3-position motorized camera port zoom	CR-DFLY-501
Dual pinhole pattern, illumination zoom, second camera port option, 3-position motorized camera port zoom	CR-DFLY-502
Full feature set: Dual pinhole pattern, illumination zoom, dual camera ports, 3-position motorized camera port zoom, TIRF, 3D lens	CR-DFLY-505

Proceed to step 2...

Step 2 Choose Additional Options for Your Selected Dragonfly Model

200 Series

First camera magnification (fixed)

Description	Option on models	Part Code
Fixed 1x magnification	201/202	TR-DFLY-PRT1-10F
Fixed 1.5x magnification	201/202	TR-DFLY-PRT1-15F
Fixed 2x magnification	201/202	TR-DFLY-PRT1-20F

First camera zoom (motorized)

Description	Option on models	Part Code
Motorized two position: 1x and 1.5x	201/202	TR-DFLY-PRT1-1015M
Motorized two position: 1x and 2x	201/202	TR-DFLY-PRT1-1020M

Second camera port (202 only)

Description	Option on models	Part Code
Second camera port	202	CR-DFLY2-CAM2-WHL



Dragonfly 200 Series Options

Second camera magnification (fixed)*

Description	Option on models	Part Code
Fixed 1x magnification	202	TR-DFLY-PRT2-10F
Fixed 1.5x magnification	202	TR-DFLY-PRT2-15F
Fixed 2x magnification	202	TR-DFLY-PRT2-20F

Second camera zoom (motorized)*

Description	Option on models	Part Code
Motorized two position: 1x and 1.5x	202	TR-DFLY-PRT2-1015M
Motorized two position: 1x and 2x	202	TR-DFLY-PRT2-1020M

Spare filter wheel

Description	Option on models	Part Code
Spare 8-position filter wheel	201/202	CR-DFLY2-WHL

* These options must be specified at time of ordering as they are not field-upgradable.

500 Series



Dragonfly 500 Series Options

Description	Option on models	Part Code
3D localisation optics*	501/502	CR-DFLY-AST
TIRF*	501/502	CR-DFLY-TIRF
Second camera port	502 only	CR-DFLY-CAM2-WHL
Spare 8-position filter wheel	501/502/505	CR-DFLY-WHL

* These options must be specified at time of ordering as they are not field-upgradable.

Step 3 Select the Cameras You Require

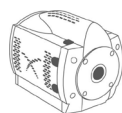

Cameras

Neo 5.5, Zyla 4.2 and 5.5 sCMOS Cameras

• Highest resolution, up to 2560 x 2160 pixels, pixel size 6.5 μm , image area up to 16.6 x 14.0 mm. QE_{max} up to >80%, TE cooled down to -40°C. See page 4 for frame rates.

• For more information: [Neo and Zyla sCMOS cameras](#)

iXon EMCCD Camera Series

• Single photon sensitive, 1024 x 1024 pixels, pixel size 13 μm , image area 13.3 x 13.3 mm. QE_{max} >95%, TE cooled to -55°C. See page 4 for frame rates.

• Add SRRF-Stream: **SRRF-STREAM-CAM**

• For more information: [iXon EMCCD cameras](#)

Step 4 Select the Required ILE Model

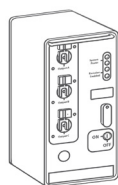

ILE & Laser options

Many combinations of the following can be supported. For specific laser wavelength configurations please speak to your Sales Engineer and refer also to the [ILE specification sheet](#).

Available Wavelengths	Power (mW)	Available Wavelengths	Power (mW)
405	100	561	50, 100, 150*
445	75	640	140
488	50, 150	685	40
514	45		

Step 5 Select Splitter, Dichroic and Filter Options

Alternatives may be considered through discussions with your Sales Engineer and subject to technical compatibility with the Dragonfly (maximum of 4 installed per unit – per cassette system).

Splitters (dual camera models only)



Splitters, Dichroics & filters

Description	Description	Part Code
100% first surface mirror	Switch between camera ports	TR-DFLY-CMDM-MIRR
500nm long-pass	CFP/YFP simultaneous imaging	TR-DFLY-CMDM-500
565nm long-pass	GFP/RFP simultaneous imaging	TR-DFLY-CMDM-565
605nm long-pass	GFP/Cy5 simultaneous imaging	TR-DFLY-CMDM-605
640nm long-pass	Cy3/Cy5 simultaneous imaging	TR-DFLY-CMDM-640
750nm long-pass	Visible/NIR dye imaging	TR-DFLY-CMDM-750

Laser dichroic mirrors and **emission filters** will be discussed with your Sales Engineer in accordance with your application requirements.

Proceed to step 6...

Step 6 Select the Required Accessories

Accessories Please discuss any additional requirements, such as motorized XY and Z stage control, incubation and accessories for your specific application needs with your Sales Engineer.

Recommended Microscopes

Model
Leica DMI8
Leica DM6 (200 series only)
Nikon Ti-E (single/dual deck)
Nikon Ti2
Nikon FN1, NiU (200 series only)

Please note, some features or components of automated microscopes may not be supported in Fusion. Please check with your Sales Engineer for more detail.

Mechanical Drawings

Dimensions in inches [mm]

200 Series

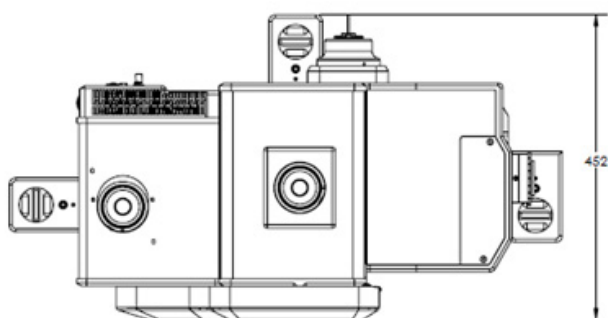
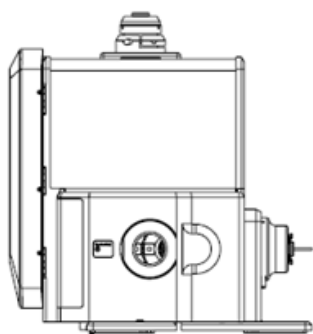
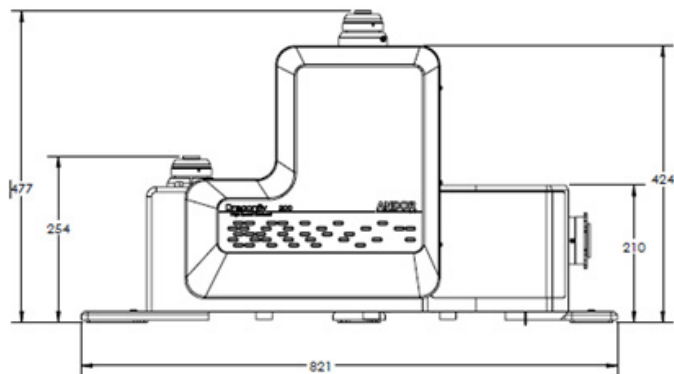

500 Series

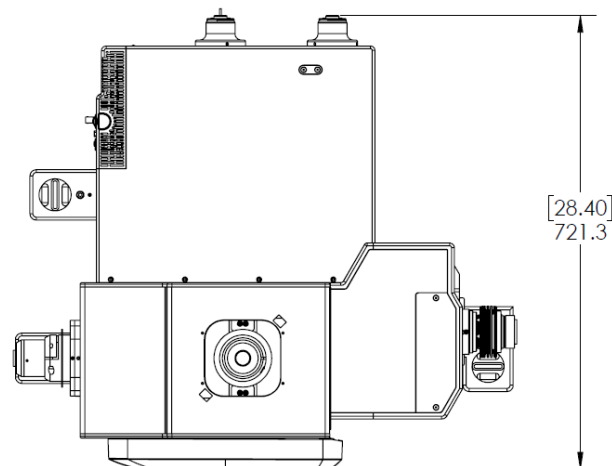
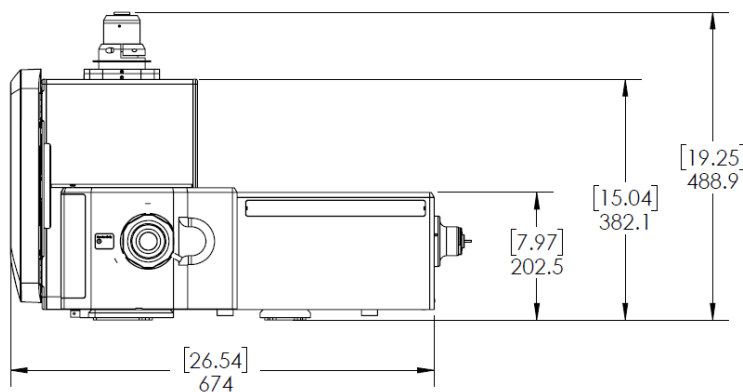
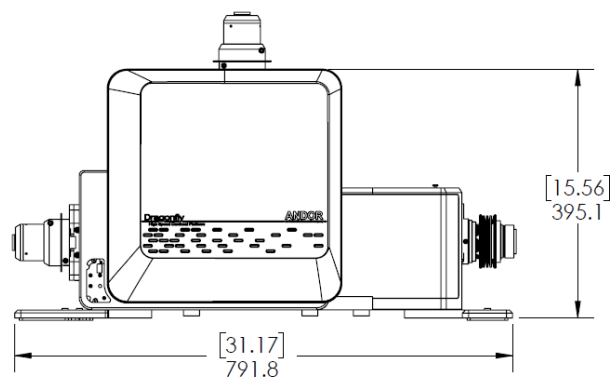

Note: Shown without installation handles, depth is 30.7 [780] with handles. For dimensions of the ILE, please refer to the [ILE specifications sheet](#).

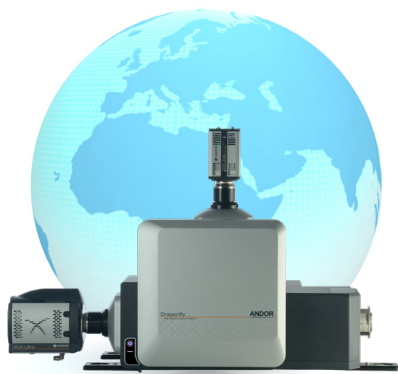

ORDER TODAY

Need more information? At Andor we are committed to finding the correct solution for you. With a dedicated team of technical advisors, we are able to offer you one-to-one guidance and technical support on all Andor products. For a full listing of our regional sales offices, please see: andor.com/contact

Our regional headquarters are:

Europe

Belfast, Northern Ireland
Phone +44 (28) 9023 7126
Fax +44 (28) 9031 0792

Japan

Tokyo
Phone +81 (3) 6732 8968
Fax +81 (3) 6732 8939

North America

Concord, MA, USA
Phone +1 (860) 290 9211
Fax +1 (860) 290 9566

China

Beijing
Phone +86 (10) 8271 9066
Fax +86 (10) 8271 9055

Items shipped with your Dragonfly

- Dragonfly base unit, cables and accessories (model as ordered)
- ILE Laser combiner (with laser options and accessories as ordered)
- Borealis BCU
- PC Workstation and accessories
- Fusion and Imaris Core Software
- User Guides in electronic format

Footnotes

1. All specifications are typical.
2. Measured for 488 nm with 40 µm pinhole pattern at Dragonfly output port. Illumination at sample may differ due to variation between microscope objectives.
3. Frame rate data shown for two typical camera options.
4. Confocal frame rates require at least 2.5 ms exposure time, synchronized with the confocal scan speed, hence they differ slightly from widefield/TIRF.
5. Burst up to camera buffer - approx. 200 - 1000 frames depending on AOI.
6. All measurements are made at 30 MHz pixel readout speed with 0.6 µs vertical clock speed. It also assumes internal trigger mode of operation. Frame rates shown are for Optically Centred ROIs.
7. Dependent on camera, zoom and objective combination.

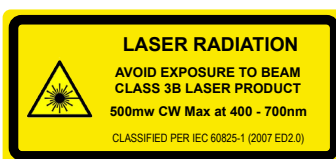

The Dragonfly system may be classified under IEC 60825-1 and CDRH 21 CFR 1040.10 as either Class 3B or 4 depending on the system configuration.



Operating & Storage Conditions:

- Operating Temperature: 18°C to +28°C ambient
- Indoor use only
- Operating Altitude: up to 2000m
- Relative Humidity: <70% (non-condensing)
- Storage Temperature: 0°C to 50°C

Power Requirements:

- External supply: 100 - 240 VAC, 50 - 60 Hz
- Power consumption - Dragonfly 300/500: 60 W/100 W (typ./ max.)
Dragonfly 200: 45 W/75 W (typ./ max.)

